

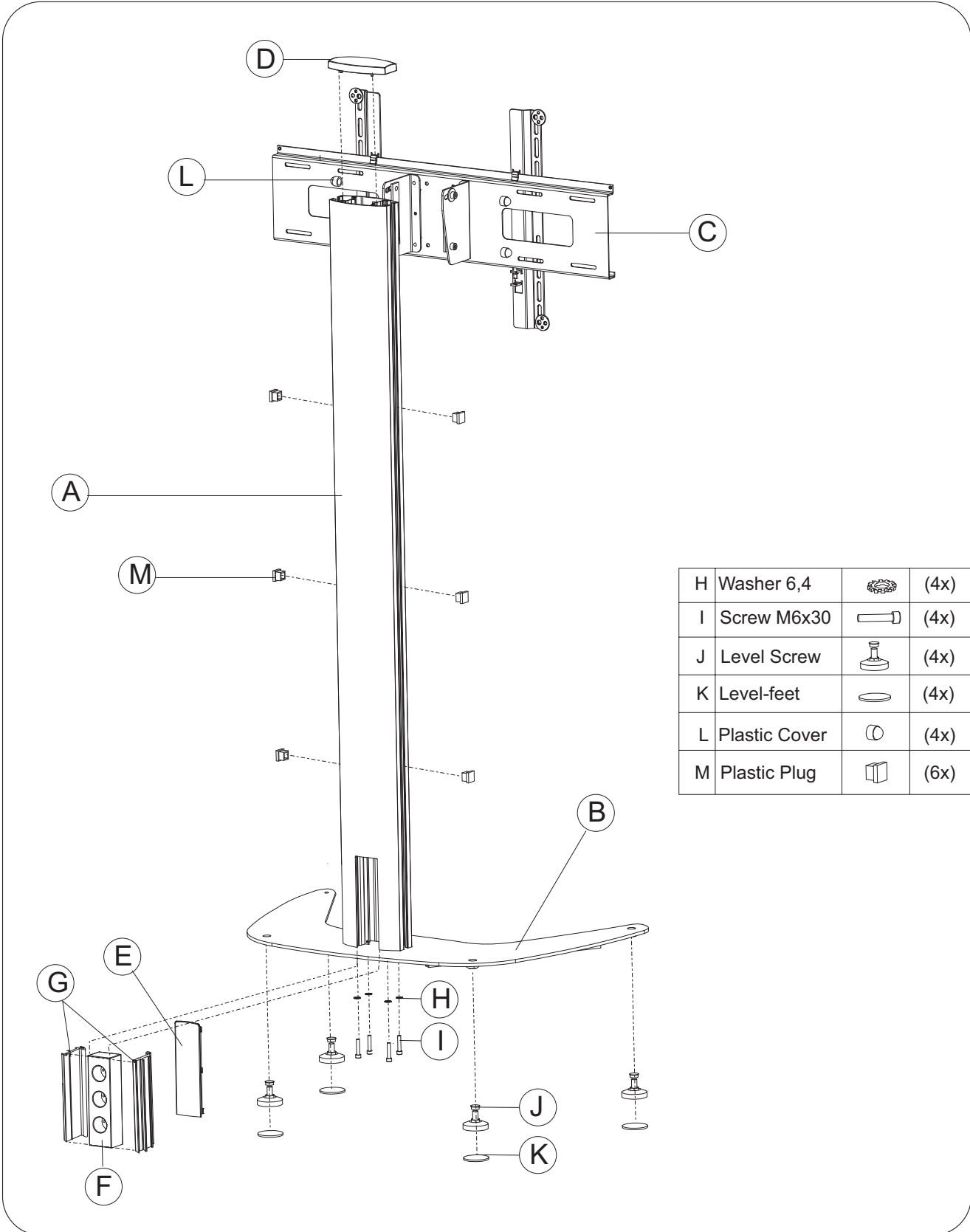

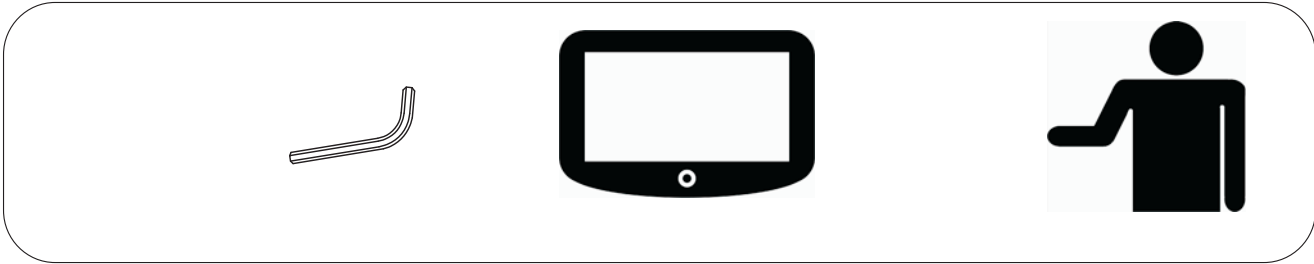



MANUAL

- GB – Instructions for Mounting
- DE – Montageinformation
- IT – Istruzioni per il montaggio
- ES – Instrucciones para el montaje
- FI – Asennusohjeet
- FR – Instructions de montage
- NL – Montagevoorschriften
- PL – Instrukcja montażu
- RUS – Инструкция по монтажу
- ARB – عربي - طريقة التركيب
- SE – Monteringsinstruktion
- GR – Πληροφορίες συναρμολόγησης





H	Washer 6,4		(4x)
I	Screw M6x30		(4x)
J	Level Screw		(4x)
K	Level-feet		(4x)
L	Plastic Cover		(4x)
M	Plastic Plug		(6x)

