

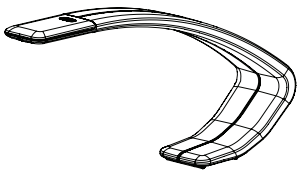
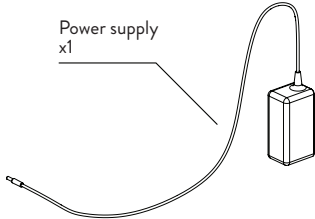
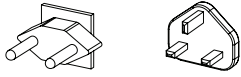

BY
L/GHTCORP

Operating Instructions for Amble Task Light

AMB/001/001

PARTS INCLUDED:		AMB/001/001	
	Amble Light x1		Power supply x1
			

1A

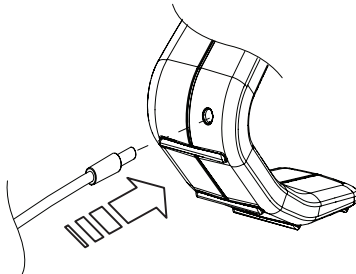

1B

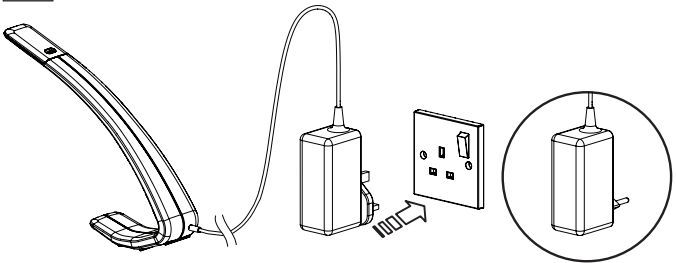

2A

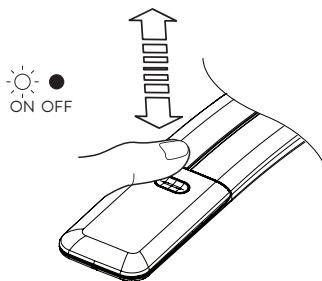

2B

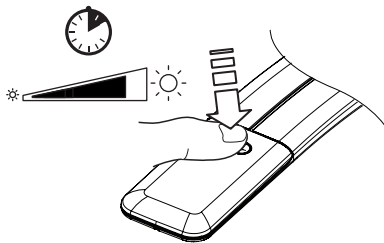

2C

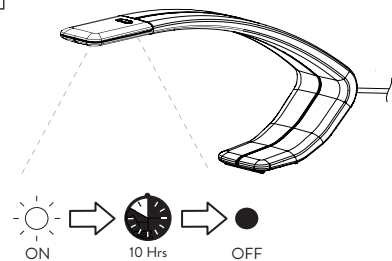

3A

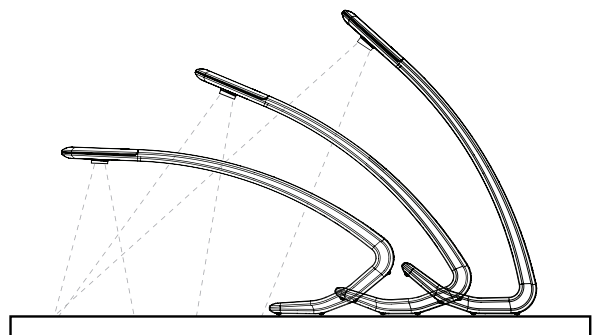
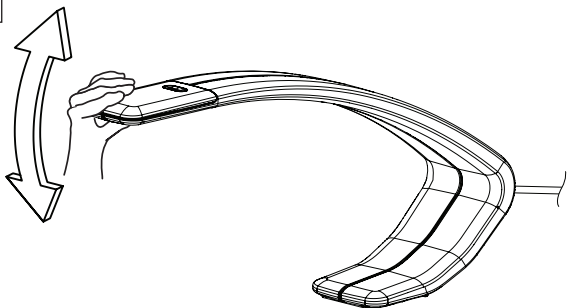



Utiliser en intérieur uniquement
(Température ambiante: 0 - 40 °C)

Nur für den Innenbereich geeignet
(Umgebungstemperatur ta.: 0 - 40 °C)



Solo para uso en interiores
(Temperatura ambiente: 0 - 40 °C)

Endast för inomhusbruk
(Tål temperaturer på högst 40°C)

Indoor use only
(Ambient temp ta.: 0 - 40 °C)

Alleen voor gebruik binnenshuis
(Omgevingstemperatuur: 0 - 40 °C)



Ne pas nettoyer avec un produit
d'entretien domestique ou un solvant.
Toujours débrancher la prise avant le
nettoyage.

Nicht mit Lösungsmitteln oder anderen
Haushaltsreinigern putzen. Gerät
vollständig austecken vor der Reinigung.



No lo limpie con disolventes ni con
otros productos de limpieza domésticos.
Desenchufe el cable antes de limpiarlo.

Vid rengöring: Dra alltid ur strömkabeln.
Använd inte lösningsmedel eller andra
rengöringsmedel.

Do not clean with solvents or other
household cleaners. Always unplug
the power cable when cleaning.

Niet reinigen met oplosmiddelen of
andere reinigingsmiddelen. Haal tijdens
het schoonmaken altijd de stekker eruit.



Ne pas utiliser dans des conditions
humides. Ne pas immerger dans un
liquide.

Gerät nicht ins Wasser tauchen und
vor Nässe schützen.

No utilize el dispositivo en lugares
húmedos ni lo introduzca en agua.

Använd inte i våtutrymmen eller i
närheten av vatten.

Do not use in wet conditions
Or immerse in water.

Niet gebruiken in natte
omstandigheden/niet in water
onderdompelen.

En cas d'avarie, ce produit ne peut pas
être réparé. Si le cordon souple est
endommagé ou si le boîtier est fissuré,
le produit ne doit plus être utilisé.

Das Produkt kann nicht repariert
werden, wenn das Gehäuse oder das
Kabel beschädigt sind. In diesem Fall
das Gerät Fachgerecht entsorgen.

El producto no puede repararse
si se estropea. Si el cable flexible
está dañado o la carcasa se agrieta,
deseche correctamente el dispositivo.

Produkten kan inte repareras om den
skadas. Om den flexibla kabeln skadas
eller om lådan skadas eller spricker,
kassera på lämpligt sätt.

The product cannot be repaired if it
is damaged. If the flexible cable is
damaged or the case is cracked or
damaged dispose of appropriately.

Een beschadigd product kan niet worden
gerepareerd. Als het flexibele snoer
beschadigd is of wanneer de behuizing
gebarsten of beschadigd is, verwijder
het dan op gepaste wijze.

Ne pas couvrir pendant l'utilisation.

Nicht abdecken, wenn im Einsatz.

No cubra el dispositivo si lo está
utilizando.

Får ej övertäckas vid användning.

Do not cover when in use.

Niet afdekken tijdens gebruik.

Dérouler le cordon sur toute sa
longueur avant d'utiliser le produit.

Kabel vor Verwendung vollständig
ausrollen.

Desenrolle totalmente el cable antes
de usarlo.

Dra ur sladden helt före användning.

Unwind cable fully before use.

Rol het snoer vóór gebruik helemaal
af.



The light source of this luminaire is not replaceable; when the light source reaches its end of life the whole luminaire shall be replaced.



DISCLAIMER

As part of our ongoing product improvement programme, the design of products may change without prior notice and details may vary from those illustrated.