

PIC-S 50 Picture Split Device

Technical Sheet

Sheet 1 of 4
ISSUE: 003

www.futureautomation.co.uk



50" VERSION SHOWN, A SMALLER 42" VERSION IS ALSO AVAILABLE.

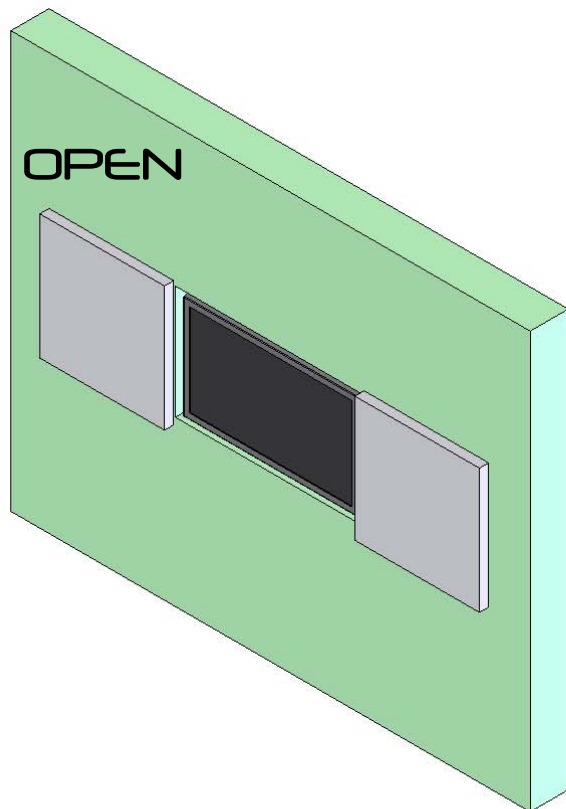

OPEN

Mechanisms
supplied as
a pair

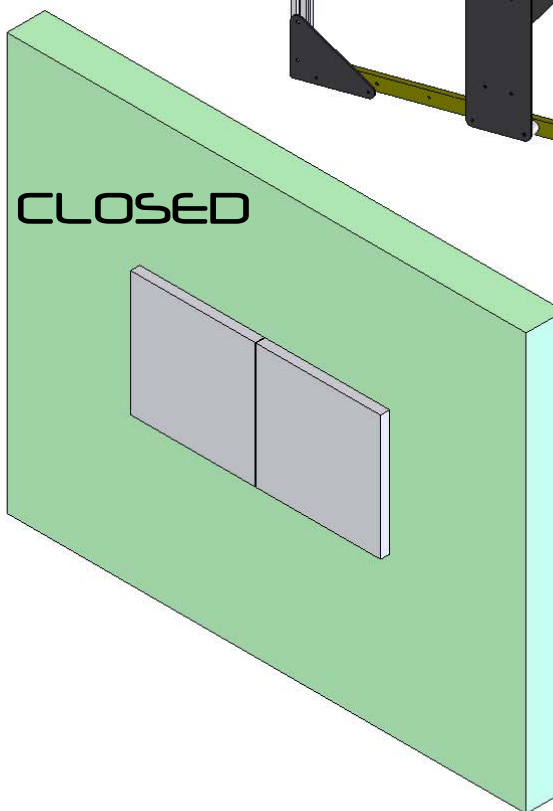
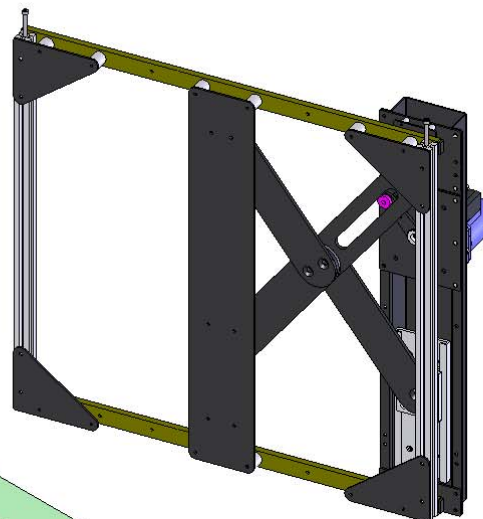

CLOSED

FUNCTION

This mechanism will open two panels to reveal a screen behind.

SUITABILITY

This technical sheet is for the smaller version of the mechanism. It is suitable for screens up to 50". See recess size for restrictions.

SPECIFYING

This mechanism requires the screen to be recessed into the wall. The mechanisms will also be recessed.

CONTROL

Supplied with basic infrared remote control. Can be learnt by many learning remotes.

Also has switch control so can be operated by relays, switches, Creston/AMX or Lutron systems.

WARNING

It is the responsibility of the installer to warn all potential end users of the dangers of interfering with mechanisms during operation

IMPORTANT

Mechanisms which lift or move weights need to be checked on a yearly basis for any damage which may result in an accident



FUTUREAUTOMATION

PIC-S 50 Picture Split Device

Technical Sheet

Sheet 2 of 4
ISSUE: 003

www.futureautomation.co.uk



CABLES

During installation there will be a need to run cables between the two outer recesses and a suitable storage location for the control box (200mm x 52mm x 150mm).

The control box will need to be plugged into a free 13amp plug socket. An infrared receiver on a 1.5m lead is also plugged into this box.

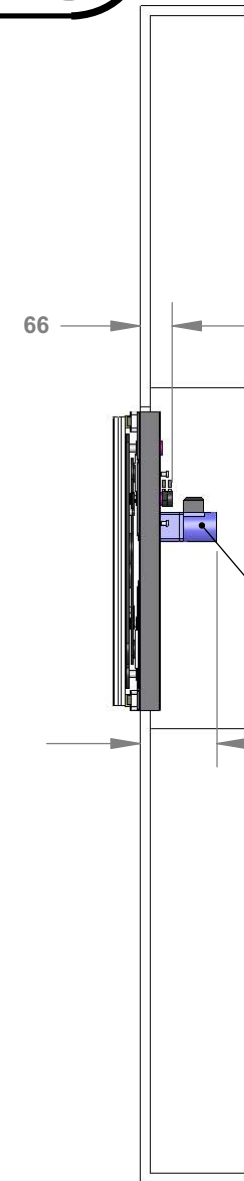
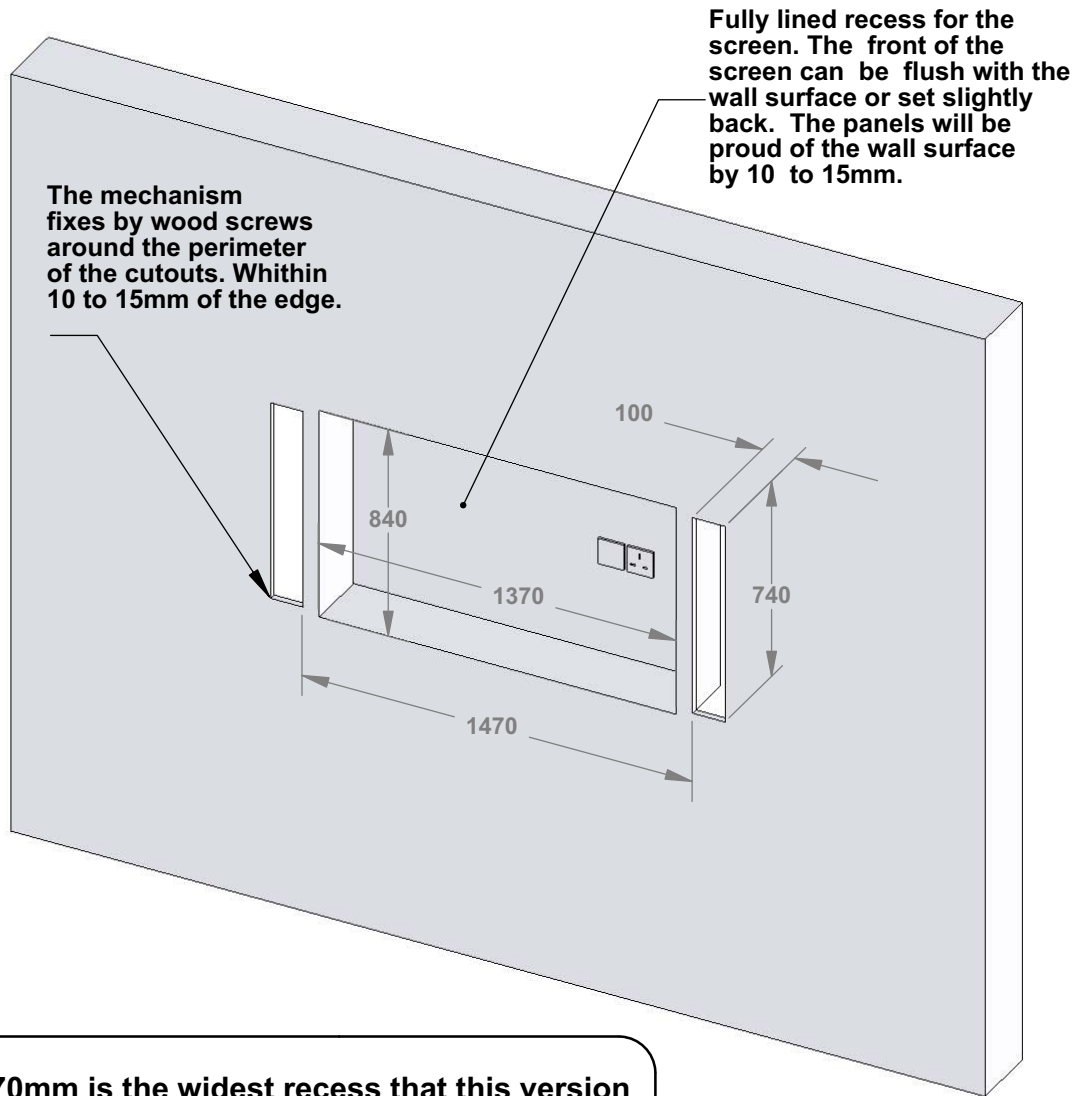

Once installed the majority of the mechanism is 66mm deep from the wall surface.

The motor requires a depth of 157mm+ on each of the mechanisms.

The screen recess would be a similar depth if a plasma swivel bracket was used as a mounting and access solution.

1370mm is the widest recess that this version of the mechanism can cover. This dimension can be reduced for small recesses but not increased.



FUTUREAUTOMATION



Panel Details

These are suggested dimensions for the panel. The most important dimension is the 45mm internal depth so that the panel covers the mechanism.

This could be a 6mm panel with canvas over.

This could help with strengthening.

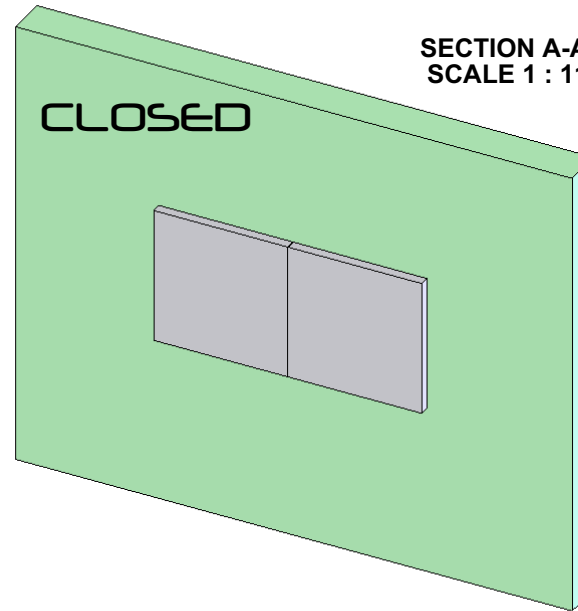
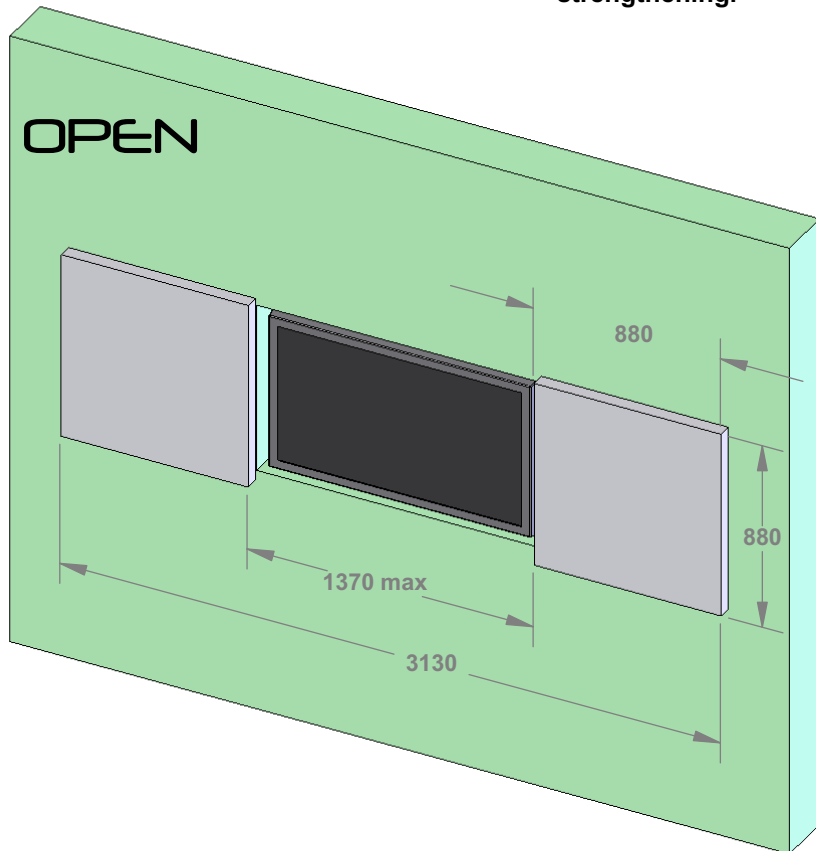
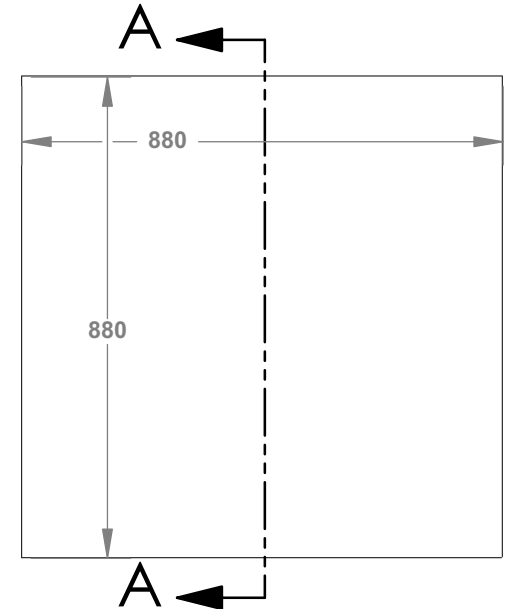
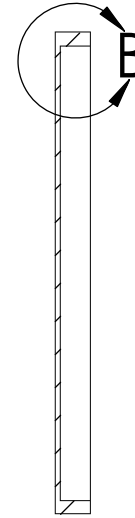
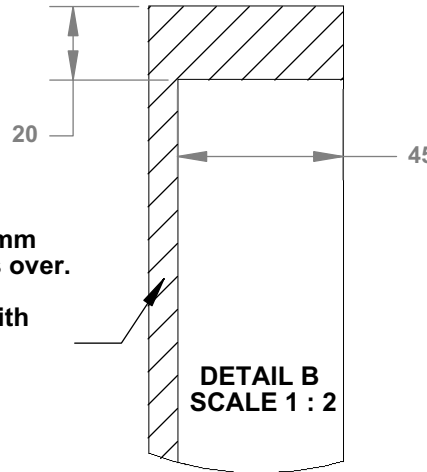

PIC-S 50 Picture Split Device

Technical Sheet

Sheet 4 of 4
ISSUE: 003
www.futureautomation.co.uk

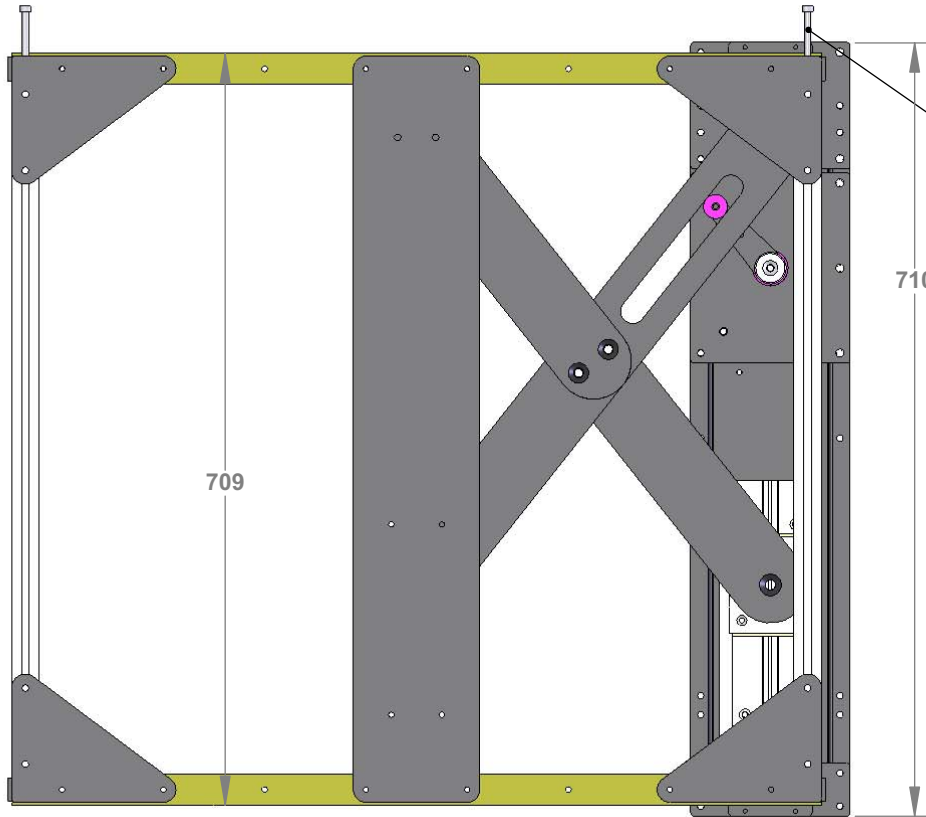

Panel hooks on to two bolts. The height of the bolts can be adjusted to level the panels.

Mechanism moves from here:

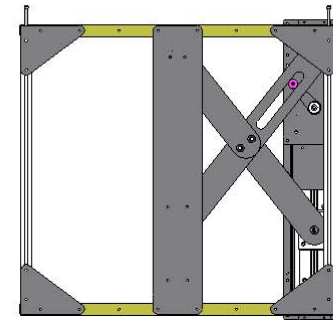

To here:

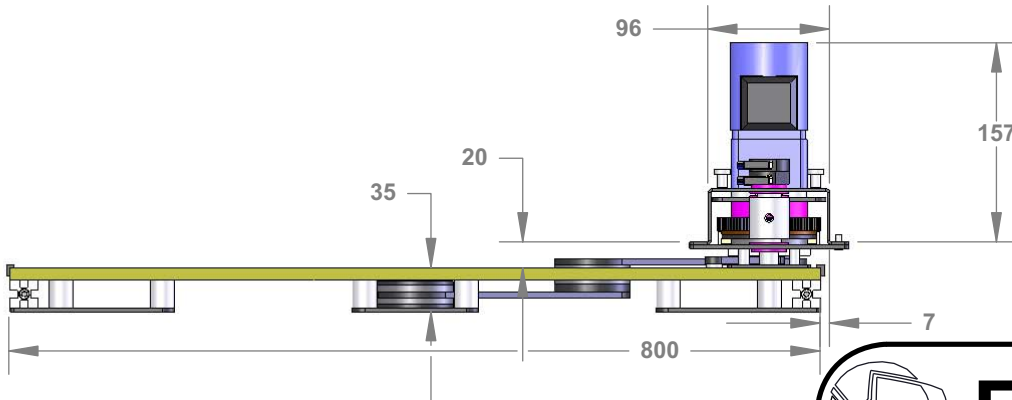
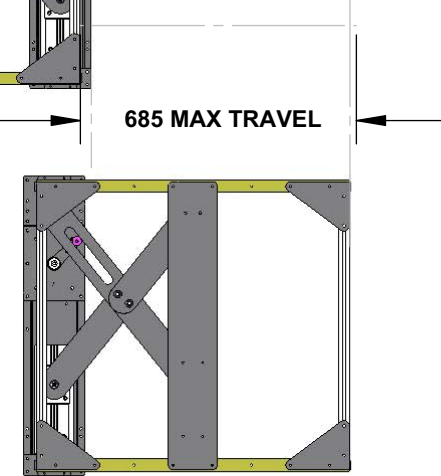

FUTUREAUTOMATION